

MODELS 10-11

Brass gas taps with safety device

Construction

Body: Forged brass
Cone: Brass
Cap: Die cast aluminium alloy
Spindle: Brass



Connections

Standard Inlet: Round 16mm. diameter
Standard Outlet: 1/4 gas male
Spindle dimension: 8x6,5mm.
 Shape according to customer's request

Brass

Installation

Maximum inlet torque: 1,5 Nm.
Maximum outlet torque: 15 Nm.
Maximum injector torque: 4 Nm.
Maximum M8x1 thermocouple torque: 4 Nm.

Functional data

Maximum working temperature: 130°C (CE) or 150°C (CSA)
Maximum working pressure: 65 mbar
Flow: 360 l/h
Internal leak tightness: < 20 cc/h (at 150 mbar)
Stroke: 4,5mm

Spindle rotation diagram

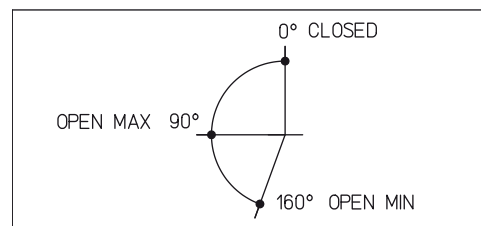

Overall dimensions

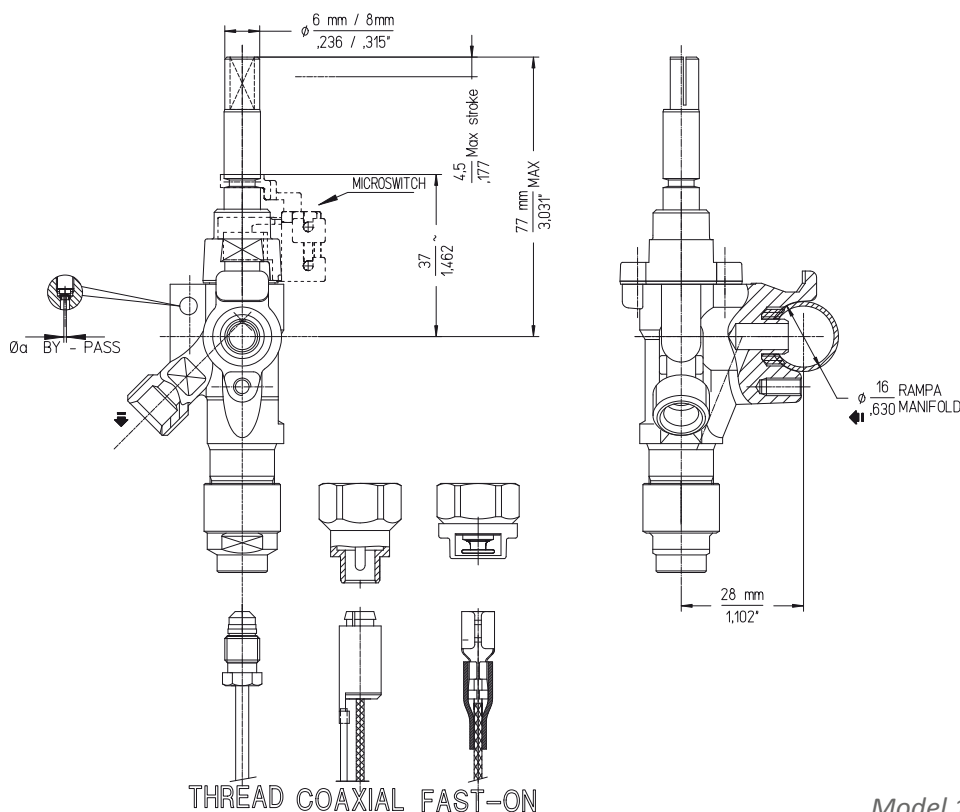

Model 10X-10Y-100-10P-10PZ-11Y

See next page 

Available spindle rotation:

MODEL 10

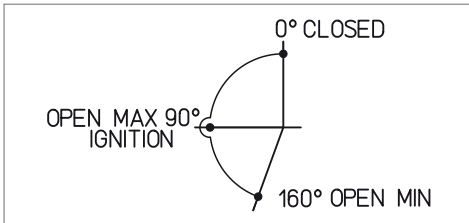

MODEL 10X

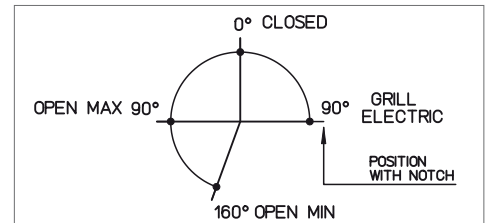

MODEL 10Y

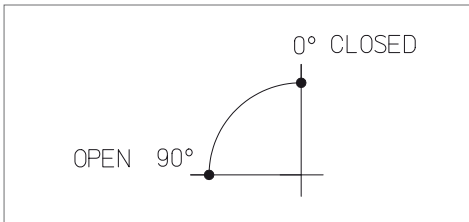

MODEL 100

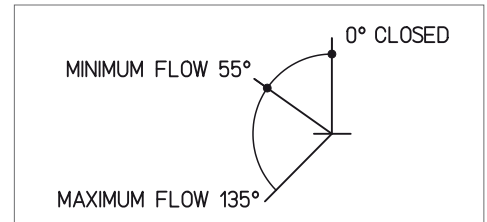

MODEL 100

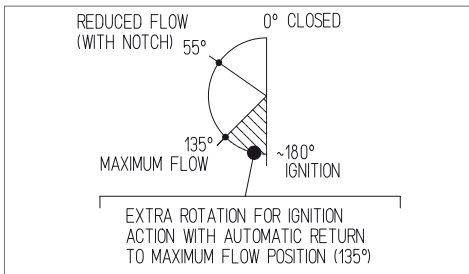

MODEL 10P

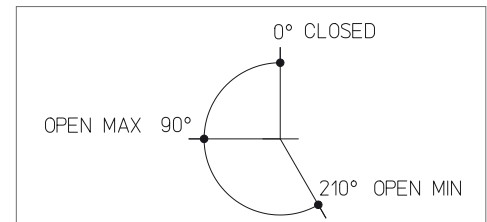

MODEL 10P

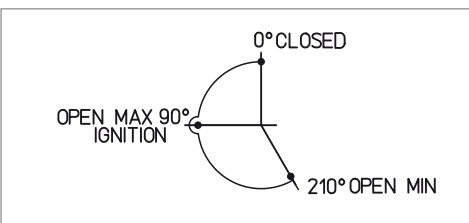

MODEL 10PZ

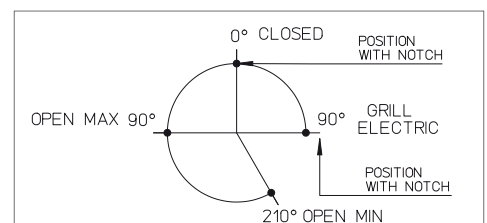

MODEL 11Y

